



inovatürk Your German source for interventional products

Seldinger Components	3
Seldinger Needles.....	4
Femoral Introducer Sets.....	5
Radial Introducer Sets.....	6
Hydrophilic Radial Introducer Sets.....	7
Y-Connector Components	9
Y-Connectors.....	10
Insertion Tool	11
Guidewire Torquers.....	11
Inflation Syringes	11
Y-Connector Sets	12
Tuohy Borst Y-Connector Sets.....	13
Push Click Y-Connector Sets	14
Push Pull Y-Connector Sets.....	15
Syringes.....	16
Control Syringes	17
Colour Coded Syringes.....	18
Vacuum Syringe Lockable	19
Safety Syringes.....	20

Stopcocks and Manifolds	21
High and Medium Pressure Stopcocks	22
2-Port Manifolds	23
3-Port Manifolds	24
4-Port Manifolds	25
Manifold Sets	26
Fluid Handling	27
Pressure Monitoring Lines.....	28
High Pressure Extension Lines	29
Compression Bandage	30
Infusion	32
Infusion Stopcocks	33
Infusion Pump	34



Seldinger Components

Seldinger Needles
Introducer Sets



Seldinger Needles

- Excellent tip for lower penetration force
- High quality easy glide 304 stainless steel
- Thin wall tube, large inner diameter
- available in sizes from 18 to 21 G, with or without Wings



Article Number	Description	Gauge	Hub Colour
98 200 1180711	70 mm with Wings	18 G	Clear
98 200 1180701	70 mm without Wings	18 G	Clear
98 200 1180702	70 mm without Wings	18 G	Pink
98 200 1190703	70 mm without Wings	19 G	Beige
98 200 1210401	40 mm without Wings	21 G	Clear

Femoral Introducer Sets

- Consists of Introducer, Dilator, Guidewire, Straightener and Needle
- Secure haemostasis valve for arterial pressure
- Excellent pushability and flexibility
- Radiopaque sheath
- Packaging Unit: 5 per box / 200 per carton

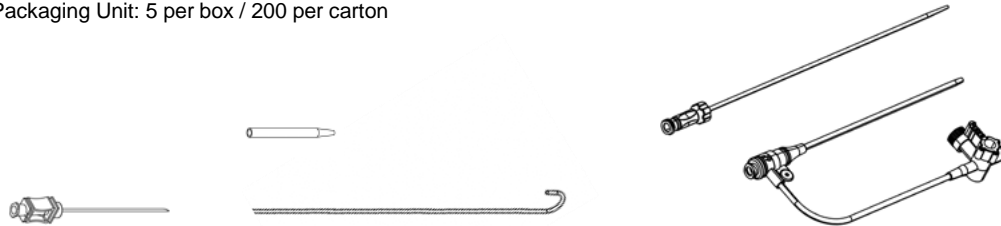

Dilator Fixation		Size		Application		Sheath / Dilator Length		Guidewire		Needle	
1	Rotate Locking	5	5F	F	Femoral	21	11 cm / 169mm	2	0.038" x 45 cm 3mm J-Style	2	18G x 7 cm
		6	6F					4	0.035" x 45 cm 3mm J-Style		
		7	7F								
		8	8F								
Art. No.	98 21	1	5	F		21		2		2	

Radial Introducer Sets

- Consists of Introducer, Dilator, Guidewire and Needle
- Secure haemostasis valve for arterial pressure
- Excellent pushability and flexibility
- Radiopaque sheath
- Packaging Unit: 5 per box / 200 per carton

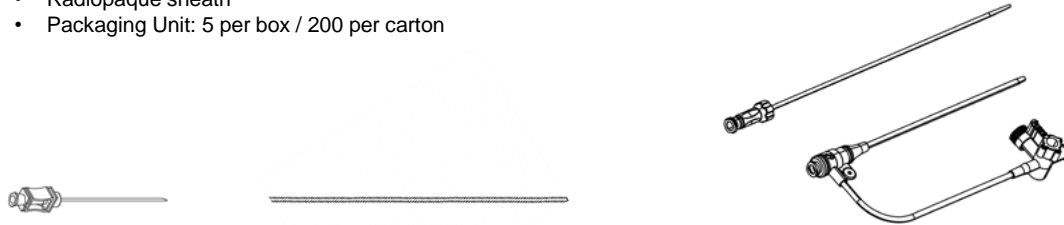

Art. No.	Dilator Fixation		Size		Application		Sheath / Dilator Length		Guidewire		Needle	
	98 21	1	Rotate Locking	5	5F	R	Radial	14	7 cm / 110mm	1	0.021" x 45cm Straight	1
			6	6F			21	11 cm / 169mm				
							32	16cm / 216mm				

Hydrophilic Radial Introducer Sets

- Consists of Introducer, Dilator, Guidewire Needle
- Hydrophilic coated radiopaque sheath provides smooth low friction insertion
- Secure haemostasis valve for arterial pressure
- Excellent pushability and flexibility
- Packaging Unit: 5 per box / 200 per carton

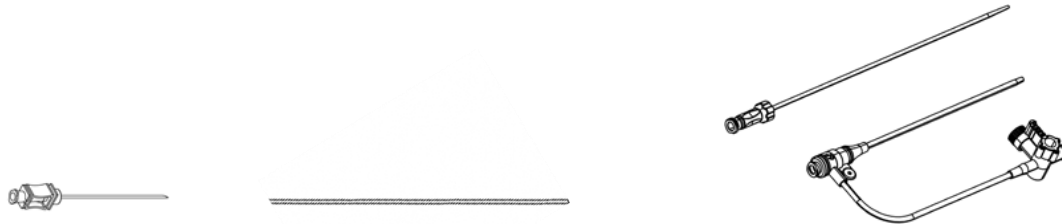

Dilator Fixation		Size		Application		Sheath / Dilator Length		Guidewire and Needle	
1	Rotate Locking	5	5F	R	Radial	51	11 cm Hydrophilic / 169 mm	11	0.021" x 45 cm Straight Guidewire with 21 G x 4 cm Arterial Needle
		6	6F					34	0.025" x 45 cm Hydrophilic Straight Guidewire with 20 G x 4,5 cm Catheter Needle
Art. No.	98 21	1	5	R		51		34	

The image shows various medical components against a blue background. At the top left, there are several clear plastic Y-connectors. To their right is a larger assembly with a gauge and a blue handle. Below these, a large gauge with a white face and black markings is visible. In the center, there is a blue handle for a guidewire torquer. At the bottom, there is a blue handle for an indeflation syringe and a long, thin metal guidewire.

Y-Connector Components

Y-Connectors
Insertion Tool
Guidewire Torquers
Indeflation Syringes

Y-Connectors

- Clear body for easy inspection
- Various options for fast lock and release
- Packaging Unit: 25 per box / 100 per carton

Note: Y-Connectors with extension lines are available under Y-Connector Sets

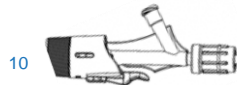

Article Number	Description
98 229 00	Tuohy Borst Y-Connector
98 229 10	Push Click Y-Connector
98 229 15	Push Pull Y-Connector

Insertion Tool

- Packaging Unit: 100 per box / 400 per carton



Article Number	Description
98 225 01	Insertion Tool 21 G Blunt

Guidewire Torquers

- Packaging Unit: 500 per box / 2000 per carton



Article Number	Description
98 224 01	for Guidewire sizes 0.014", ABS Collar
98 224 02	for Guidewire sizes 0.014", Metal Collar
98 224 03	for Guidewire sizes 0.035", Metal Collar
98 224 04	for Guidewire sizes 0.038", Metal Collar

Indeflation Syringes

- Accurate pressure control with angled gauge and 12" x 1200 psi High Pressure Line
- Push button to release pressure for fast and easy operation
- 3-way stopcocks included according to the required pressure rates
- Packaging Unit: 5 per box / 20 per carton

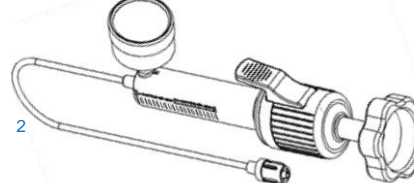
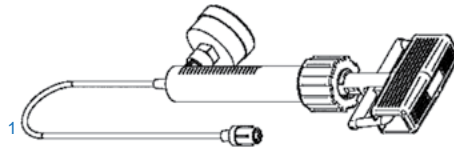

Art. No.	Handly Type		Size		Pressure Rate		Stopcock	
	1	2	20	20ml	30	30 atm	0	no Stopcock
98 221	2		20		40		2	

The background of the slide is a semi-transparent blue overlay on a photograph of medical equipment. Visible items include a syringe with a needle, a pressure gauge with a circular scale, and various plastic connectors and tubing. The text is centered over the image.

Y-Connector Sets

Tuohy Borst Y-Connector Sets
Push Click Y-Connector Sets
Push Pull Y-Connector Sets

Tuhy Borst Y-Connector Sets

- Consists of Y-Connector with/without extension line, and optional Insertion Tool, Torquer and Indeflation Syringe
- Y-Connector with clear body
- Packaging Unit for Sets without Indeflation Syringe: 25 per box / 100 per carton;
with Indeflation Syringe: 5 per box / 20 per carton

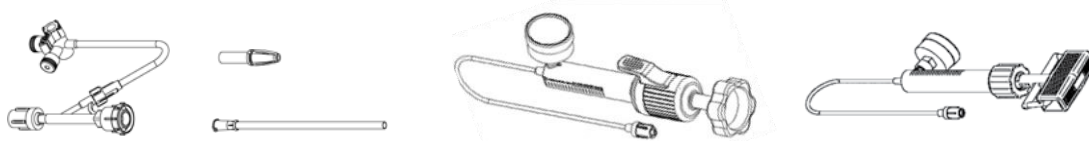

Tuhy Borst + Type		Insertion Tool		Torquer		Indeflation Syringe	
00	no Extension Line	0	no Insertion Tool	0	no Torquer	0	no Indeflation Syringe
01	25 cm Extension Line & Standard Pressure Stopcock	1	21 G x 95cm, Blunt	1	for 0.014" Wire, ABS Collar	1	20ml, 30atm, Round Handle, no Stopcock
03	50 cm Extension Line & Standard Pressure Stopcock			2	for 0.038" Wire, Metal Collar	2	20ml, 30atm, Round Handle, High Pressure Stopcock
						5	20ml, 30atm, T-Handle, no Stopcock
						6	20ml, 30atm, T-Handle, High Pressure Stopcock
						7	20ml, 40atm, T-Handle, no Stopcock
						8	20ml, 40atm, T-Handle, High Pressure Stopcock
Art. No.	98 229 00	1		2		2	

Push Click Y-Connector Sets

- Consists of Y-Connector with/without extension line, and optional Insertion Tool, Torquer and Inflation Syringe
- Y-Connector with clear body
- Packaging Unit for Sets without Inflation Syringe: 25 per box / 100 per carton;
with Inflation Syringe: 5 per box / 20 per carton

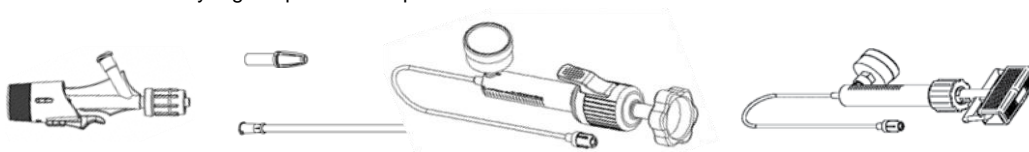

Push Click + Type		Insertion Tool		Torquer		Inflation Syringe	
10	no Extension Line	0	no Insertion Tool	0	no Torquer	0	no Inflation Syringe
11	25 cm Extension Line & Standard Pressure Stopcock	1	21 G x 95cm, Blunt	1	for 0.014" Wire, ABS Collar	1	20ml, 30atm, Round Handle, no Stopcock
13	50 cm Extension Line & Standard Pressure Stopcock			2	for 0.038" Wire, Metal Collar	2	20ml, 30atm, Round Handle, High Pressure Stopcock
						5	20ml, 30atm, T-Handle, no Stopcock
						6	20ml, 30atm, T-Handle, High Pressure Stopcock
						7	20ml, 40atm, T-Handle, no Stopcock
						8	20ml, 40atm, T-Handle, High Pressure Stopcock
Art. No.	98 229 10	1		2		1	

Push Pull Y-Connector Sets

- Consists of Y-Connector with/without extension line, and optional Insertion Tool, Torquer and Inflation Syringe
- Y-Connector with clear body
- Packaging Unit for Sets without Inflation Syringe: 25 per box / 100 per carton;
with Inflation Syringe: 5 per box / 20 per carton

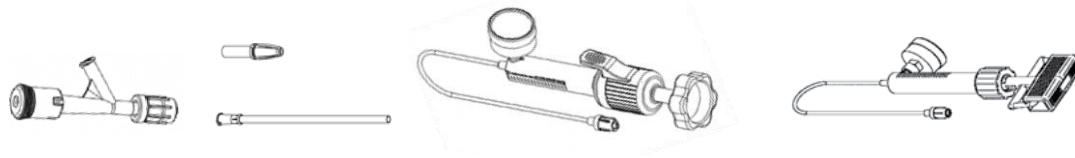

Push Click + Type		Insertion Tool		Torquer		Inflation Syringe	
15	no Extension Line	0	no Insertion Tool	0	no Torquer	0	no Inflation Syringe
16	25 cm Extension Line & Standard Pressure Stopcock	1	21 G x 95 cm, Blunt	1	for 0.014" Wire, ABS Collar	1	20ml, 30atm, Round Handle, no Stopcock
18	50 cm Extension Line & Standard Pressure Stopcock			2	for 0.038" Wire, Metal Collar	2	20ml, 30atm, Round Handle, High Pressure Stopcock
						5	20ml, 30atm, T-Handle, no Stopcock
						6	20ml, 30atm, T-Handle, High Pressure Stopcock
						7	20ml, 40atm, T-Handle, no Stopcock
						8	20ml, 40atm, T-Handle, High Pressure Stopcock
Art. No.	98 229	15	1	2		1	



Syringes

- Control Syringes
- Colour Coded Syringes
- Vacuum Syringe Lockable
- Safety Syringes



Control Syringes

- Accurate dosage control
- Simple operation and easy to use
- Latex free
- For clinician's comfort: Ergonomic configurations with palm pad or thumb ring and finger plate or finger ring
- Low plunger force
- Clear body
- Packaging Unit: 25 per box / 100 per carton

Size		Luer Type	
006	6 ml	LL	Male Luer Lock, Thumb Ring/ Finger Ring
008	8 ml	RA	Rotating Adaptor, Thumb Ring/ Finger Ring
010	10 ml	PP	Male Luer Lock, Palm Pad / Finger Plate
012	12 ml	PR	Male Luer Lock, Palm Pad / Finger Ring
		TF	Male Luer Lock, Thumb Ring / Finger Plate
Art. No.	98 311 010	RA	

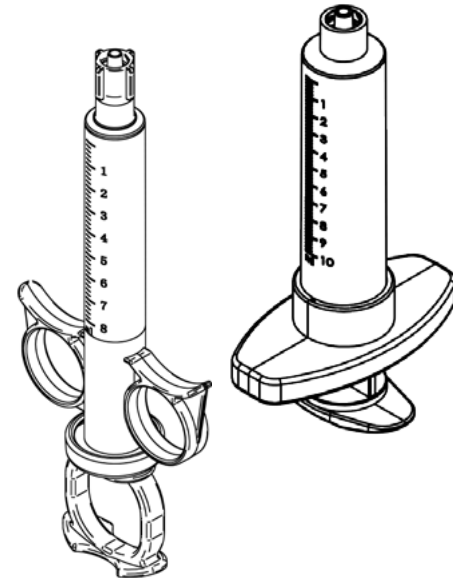

Colour Coded Syringes

- Smooth plunger operation
- Clear scale printing
- Clear Polycarbonate
- Packaging Unit: 25 per box / 100 per carton

Size		Luer Type		Plunger Colour	
001	1 ml*	LL	Luer Lock	1	White
010	10ml			2	Blue
020	20ml			3	Purple
				4	Red
				5	Yellow
				7	Dark Green
Art. No.	98 303 010		LL		7

* 1 ml Syringe only available with white plunger

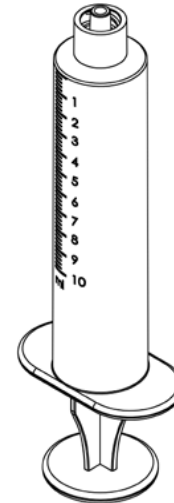

Vacuum Syringe Lockable

- Locking ring to fix aspiration volume
- White plunger colour
- Packaging Unit: 20 per box / 80 per carton

Art. No.	Size		Luer Type	
	98 305	030	30 ml	LL

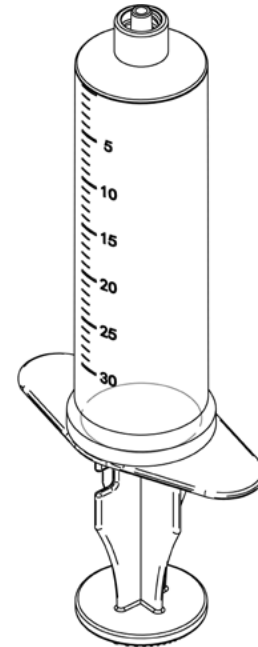

Safety Syringes

- No more needle stick - Needle retracts fully into the syringe barrel after injection
- Luer Lock Connector comes back together with the plunger and needle after injection
- Designed for safety of both nurses and patients

Size		Luer Type		Plunger Colour		Needle Type	
003	3ml	RMLL	Retracting MLL	1	white	00	no needle
005	5ml					21	21 g x 1.5" hypodermic needle
010	10ml					22	22 g x 1.5" Hypodermic needle
020	20ml					23	23 g x 1.5" Hypodermic needle
						24	24 g x 1.5" Hypodermic needle
						25	25 g x 1.5" Hypodermic needle
						26	26 g x 1.5" Hypodermic needle
						27	27 g x 1.5" Hypodermic needle
						28	28 g x 1.5" Hypodermic needle
						29	29 g x 1.5" Hypodermic needle
						30	30 g x 1.5" Hypodermic needle
						31	31 g x 1.5" Hypodermic needle
Art. No.	98 SS 003	RMLL		1		31	

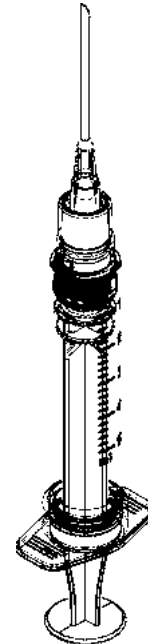



Stopcocks and Manifolds

High and Medium Pressure Stopcocks

2-Port Manifolds

3-Port Manifolds

4-Port Manifolds

Manifold Sets

High and Medium Pressure Stopcocks

- Smooth handle operation
- Clear body for easy inspection in use
- Rated to 500 or 1200 psi
- Packaging Unit: 200 per box / 800 per carton

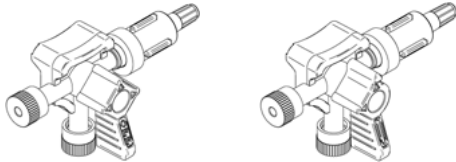

Pressure Rating		Number of Ways		Handle Type		Handle Colour / Pressure Rating		Connection Port	
5	500psi	3	3-Way	9	ON	2	White, 1200psi	1	Rotating Adaptor
7	1200psi			8	OFF				
Art. No.	98 231	7		3		9		2	

2-Port Manifolds

- Smooth handle operation
- Clear body for easy inspection in use
- Rated to 500 psi
- Ergonomically shaped for comfort
- Packaging Unit: 25 per box / 100 per carton

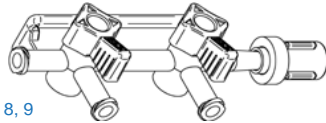

8, 9

Pressure Rating		Number of Ports		Hand		Body Type		Handle Type		Handle Colour		Connection Port	
5	500 psi	2	2-Port	LH	Left Hand	1	Curved Body	9	ON	1	Blue	1	Rotating Adaptor
				RH	Right Hand	2	Open Body	8	OFF	2	White		
						3	Block Body	7	ON Soft Handle	3	Red		
								6	OFF Soft Handle				
Art. No.	98 232	5		2		LH		3		9		1	

3-Port Manifolds

- Smooth handle operation
- Clear body for easy inspection in use
- Rated to 500 psi
- Ergonomically shaped for comfort
- Packaging Unit: 25 per box / 100 per carton



8, 9

Art. No.	Pressure Rating		Number of Ports		Hand		Body Type		Handle Type		Handle Colour		Connection Port	
	5	500 psi	3	3-Port	LH	Left Hand	1	Curved Body	9	ON	1	Blue	1	Rotating Adaptor
					RH	Right Hand	2	Open Body	8	OFF	2	White	2	Extension Line
							3	Block Body	7	ON Soft Handle	3	Red		
									6	OFF Soft Handle				
98 232	5		3		RH		2		9		1		1	

4-Port Manifolds

- Smooth handle operation
- Clear body for easy inspection in use
- Rated to 500psi
- Ergonomically shaped for comfort
- Packaging Unit: 25 per box / 100 per carton

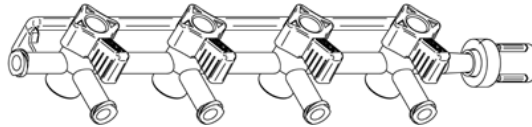

8, 9

Art. No.	Pressure Rating		Number of Ports		Hand		Body Type		Handle Type		Handle Colour		Connection Port	
	5	500psi	4	4-Port	LH	Left Hand	1	Curved Body	9	ON	1	Blue	1	Rotating Adaptor
					RH	Right Hand	2	Open Body	8	OFF	2	White		
							3	Block Body	7	ON Soft Handle	3	Red		
									6	OFF Soft Handle	4	Red, Blue, Green		
											5	Red, Blue		
98 232	5		4		LH		2		9		1		1	

Manifold Sets

- Customized sets available upon request.
- Rated to 500psi

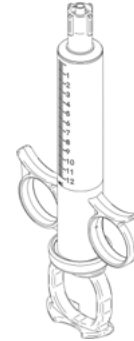
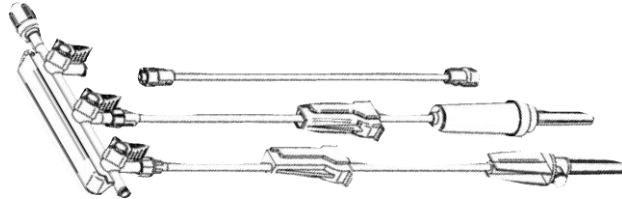

Number of Ports		Hand		Infusion Lines		Syringe Addition		Component Addition	
2	2-Port	RF	Right Hand OFF	00	no Lines	00	no Addition	00	no Addition
3	3-Port	RN	Right Hand ON	01	120 cm Monitoring Line + 2 x 180cm Drip Chamber Lines	01	12 ml RA Control Syringe	01	HP Stopcock 3-Way OFF
4	4-Port	LF	Left Hand OFF	02	120 cm Monitoring Line + 2 x 275 cm Vented Drip Chamber Lines	02	12 ml LL Control Syringe		
		LN	Left Hand ON	03	120 cm Monitoring Line + 2 x 180cm Drip Chamber Lines + 30cm HP Line	03	10 ml RA Control Syringe		
						04	10 ml LL Control Syringe		
Art. No.	98 250	4	RN			04		00	



Fluid Handling

Pressure Monitoring Lines
High Pressure Extension Lines

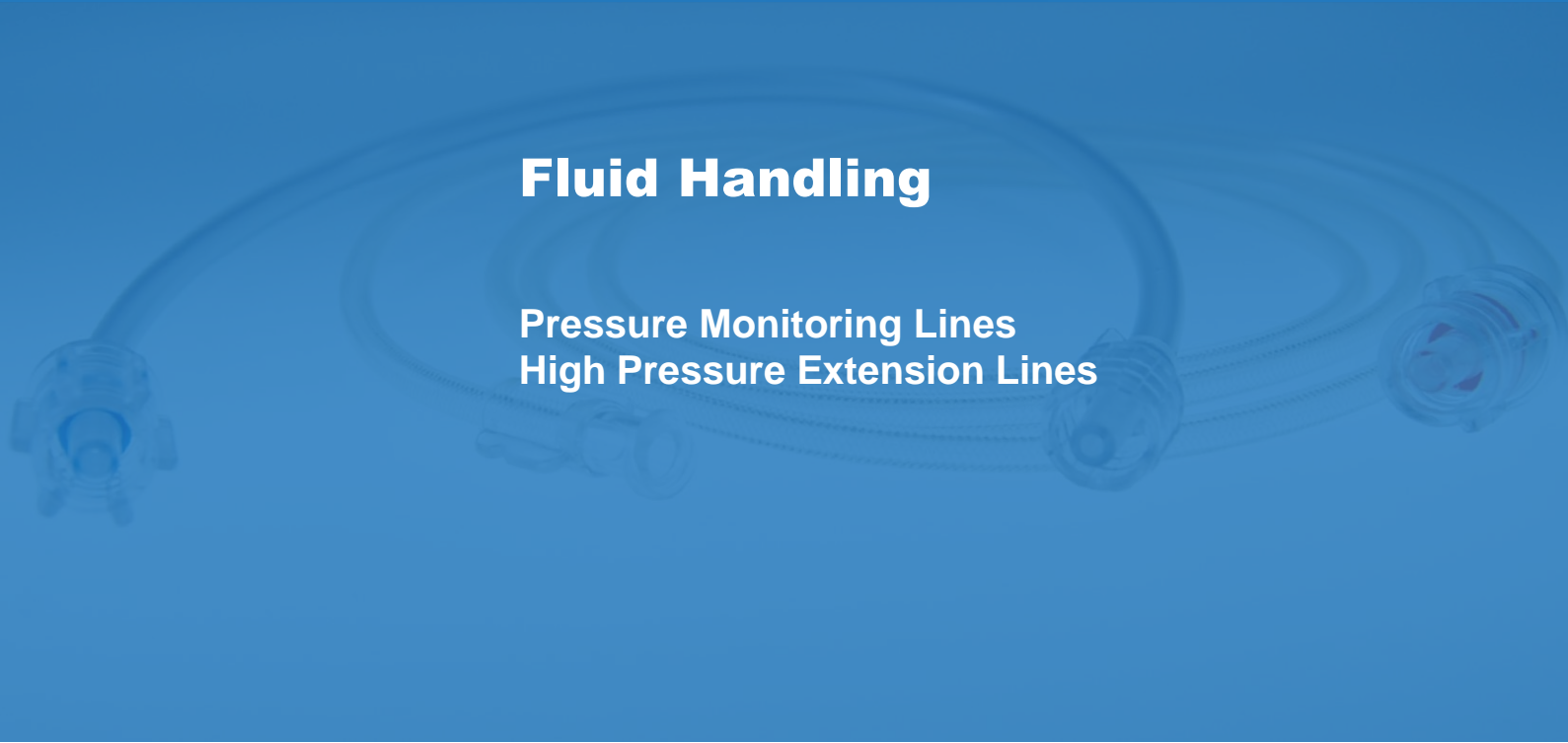

Pressure Monitoring Lines

- Rated to 500psi
- Packaging Units:

Article No.	Box/Carton Quantity
98 241 030 - 150	100/400
98 241 180 - 240	50/200



Length		Material		Pressure Rate		Connection Ports		
030	30 cm	1	DEHP Free PVC	5	500psi	0	Male / Female LL	
060	60 cm	2	PVC			1	Male / Male LL	
090	90 cm							
120	120 cm							
150	150 cm							
180	180 cm							
210	210 cm							
240	240 cm							
Art. No.	98 240	120		1		5		1

High Pressure Extension Lines

- Rated to 1200psi
- Packaging Units:

Article No.	Box/Carton Quantity
98 241 030 - 060	100/400
98 241 090	90/360
98 241 120	80/320
98 241 150	60/240



Length		Material		Pressure Rate		Connection Ports	
030	30 cm	3	PA	7	1200 psi	0	Male / Female LL
060	60 cm					1	Male / Male LL
090	90 cm					3	Female LL / Male RA
120	120 cm					4	Male RA / Male RA
150	150 cm						
Art. No.	98 241 120	3		7		3	



Compression Bandage



Compression Bandage

- Easy adjustment of compression pressure
- Scale for reference
- No effect on venous blood circulation
- Soft easy fix band for comfort
- Packaging Unit: 20 per box / 100 per carton

Type		Size	
1	Radial	18	18cm
2	Femoral	22	22cm
		26	26cm
1		INF	Inflating
Art. No.	98 217	1	INF

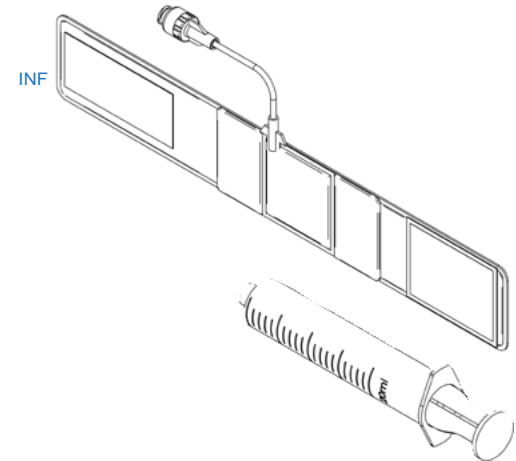

18, 22, 26

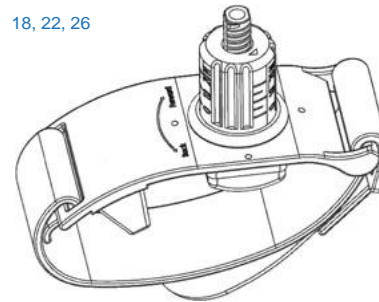



Infusion

Infusion Stopcocks
Infusion Pump



Infusion Stopcocks

- Smooth handle operation
- Clear body for easy inspection in use
- Rated to 45 psi
- Packaging Unit: 250 per box / 1000 per carton

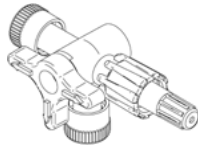

Pressure Rating		Number of Ways		Handle Type		Handle Colour		Connection Port		Material	
4	45 psi	1	1-Way	7	T-Handle	1	Blue	2	Extension Line	5	Polycarbonate
		3	3-Way	8	OFF	2	White	3	Male Luer Lock		
		4	4-Way	9	ON	3	Red				
Art. No.	98 400	4		4		7		3		3	

Infusion Pump

- Constant pressure provides accurate flow during infusion
- Filter vents air automatically and prevents particles ($\leq 2 \mu\text{m}$)
- Unique pressure balance provides stable 10kPa pressure (standard pressure for infusion)
- Pre set flow rates between 60ml/h and 300ml/h



ml/hr setting		Accessories	
060	60ml/hr	1	Pressure Balancer, Flow Regulator
100	100 ml/hr	2	Patient Bolus Button
200	200 ml/hr		
300	300 ml/hr		
Art. No.	98 403 100	1	



+90 (212) 210 20 20



info@inovaturk.com.tr



www.inovaturk.com.tr

Ataşehir bulvarı, Atatürk Mah. Evinpark Rezidans No:23 a-1 blok d.24 Ataşehir / İSTANBUL